

FRONT WALL PROFILE  
SCALE: 1/4"=1'

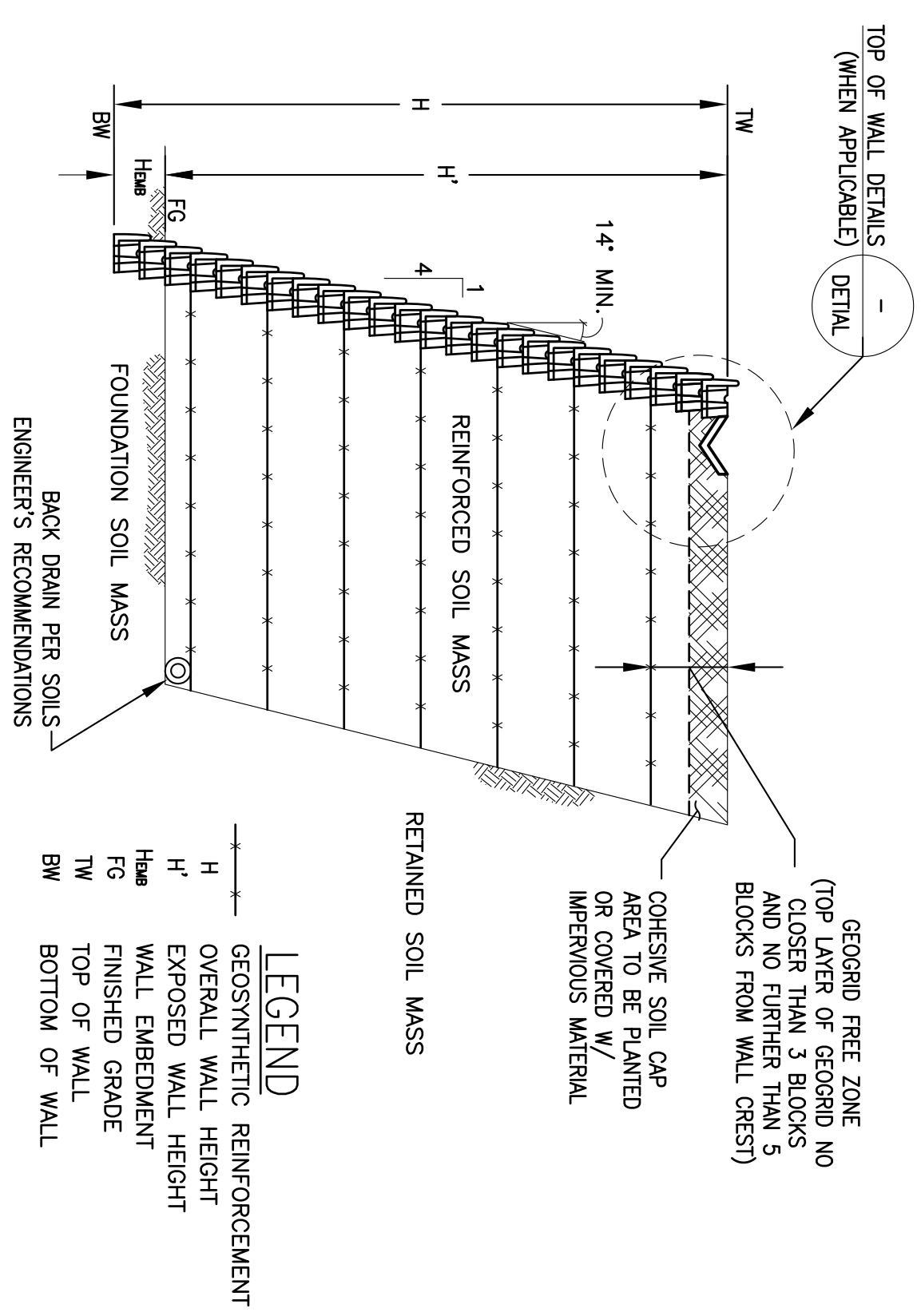

TYPICAL CROSS - SECTION  
SCALE: 1/4"=1'

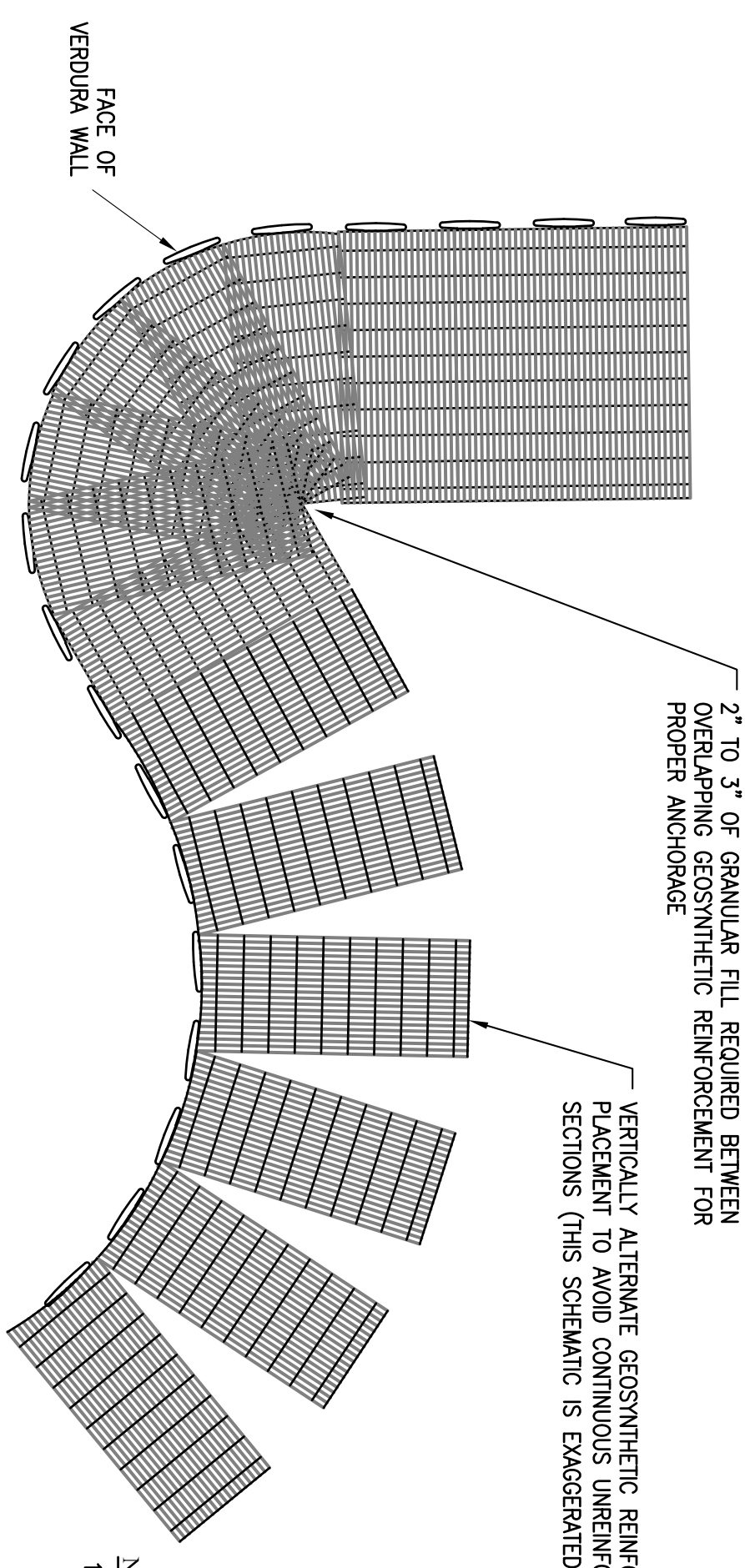

GEOGRID PLACEMENT ON CURVES  
SCALE: 1/4"=1'

NOTES:  
1. CHECK WITH MANUFACTURER'S SPECIFICATIONS FOR THE CORRECT ORIENTATION OF THE GEOSYNTHETIC REINFORCEMENT TO OBTAIN PROPER STRENGTH.

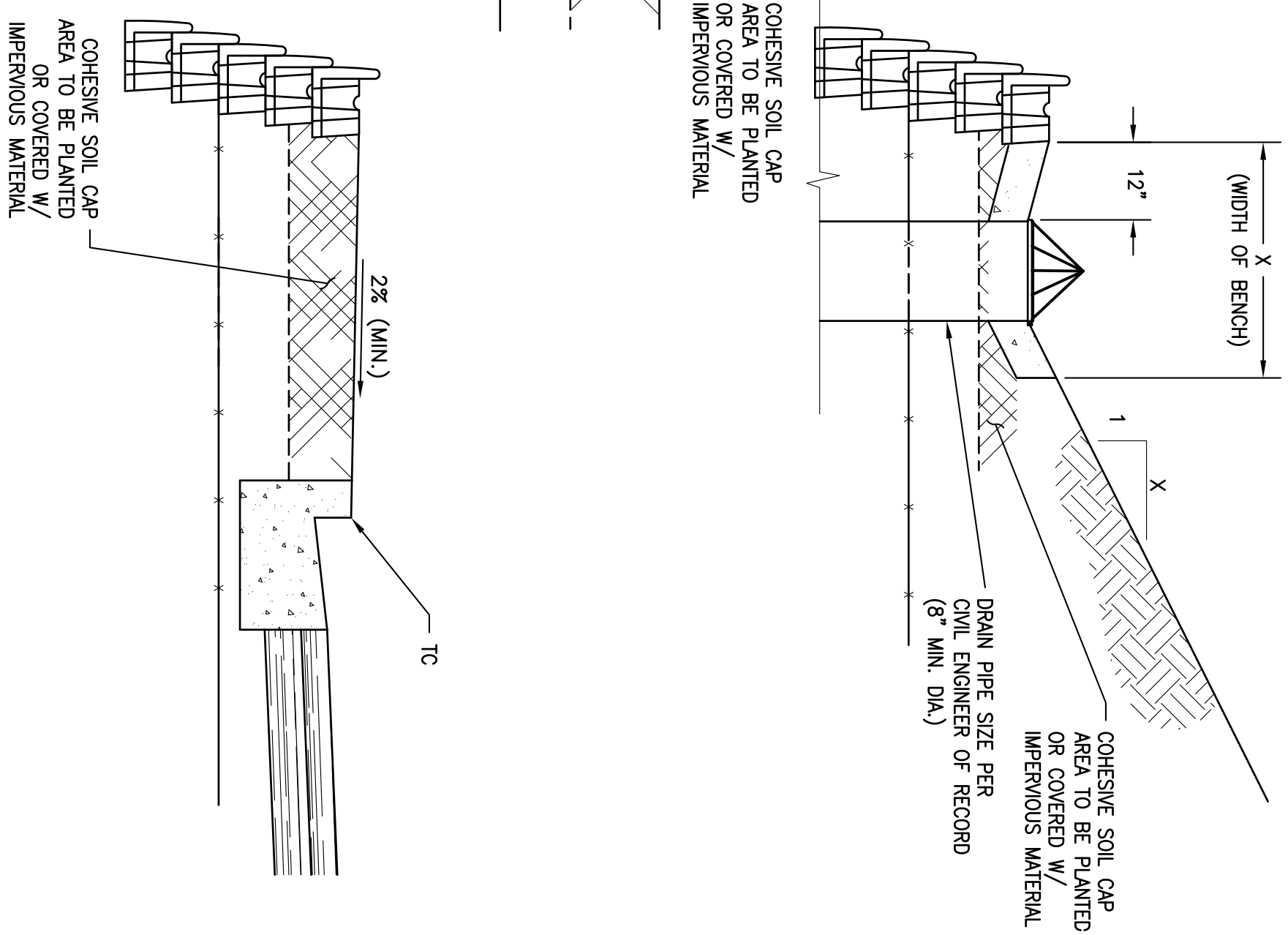
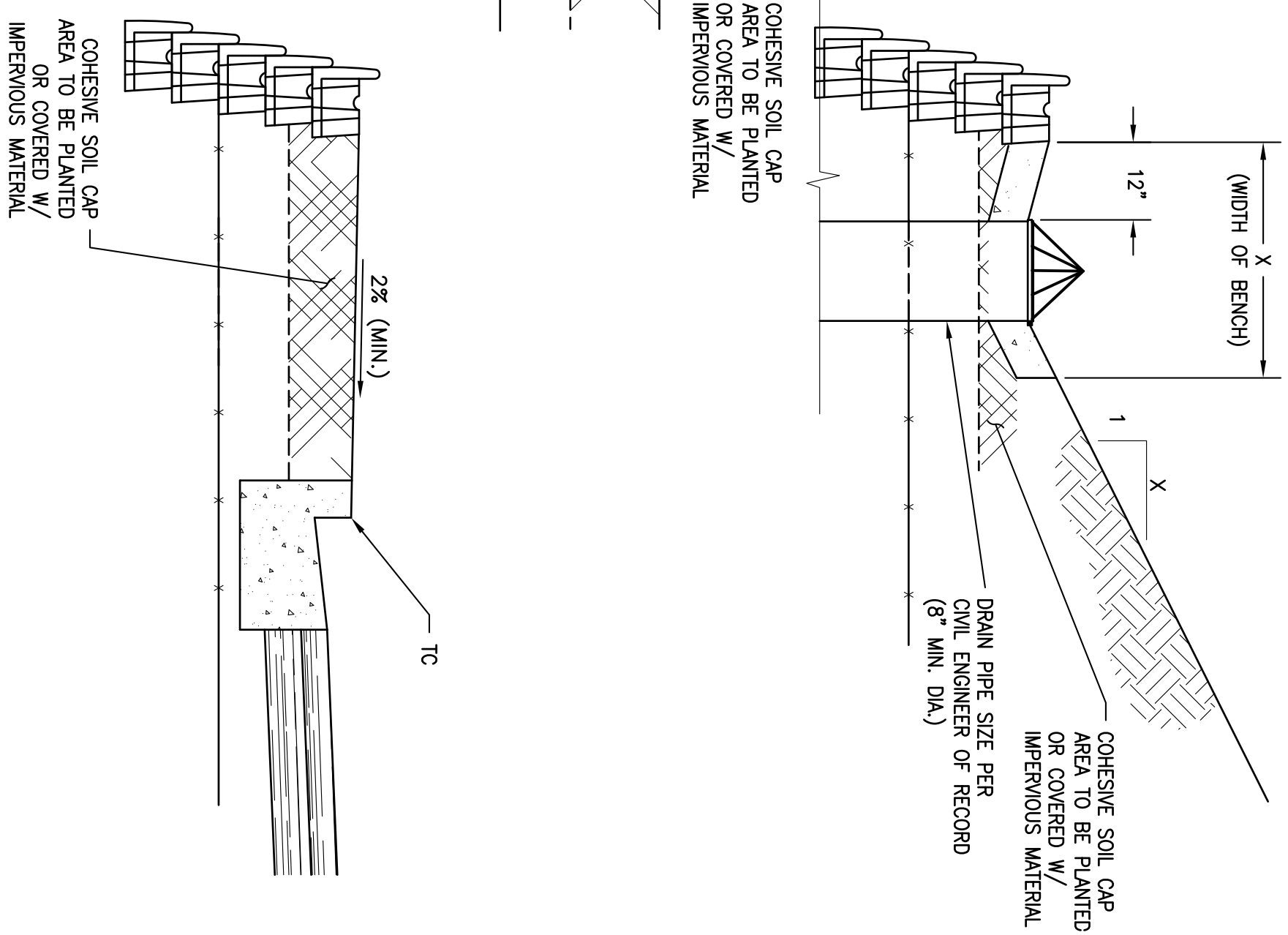
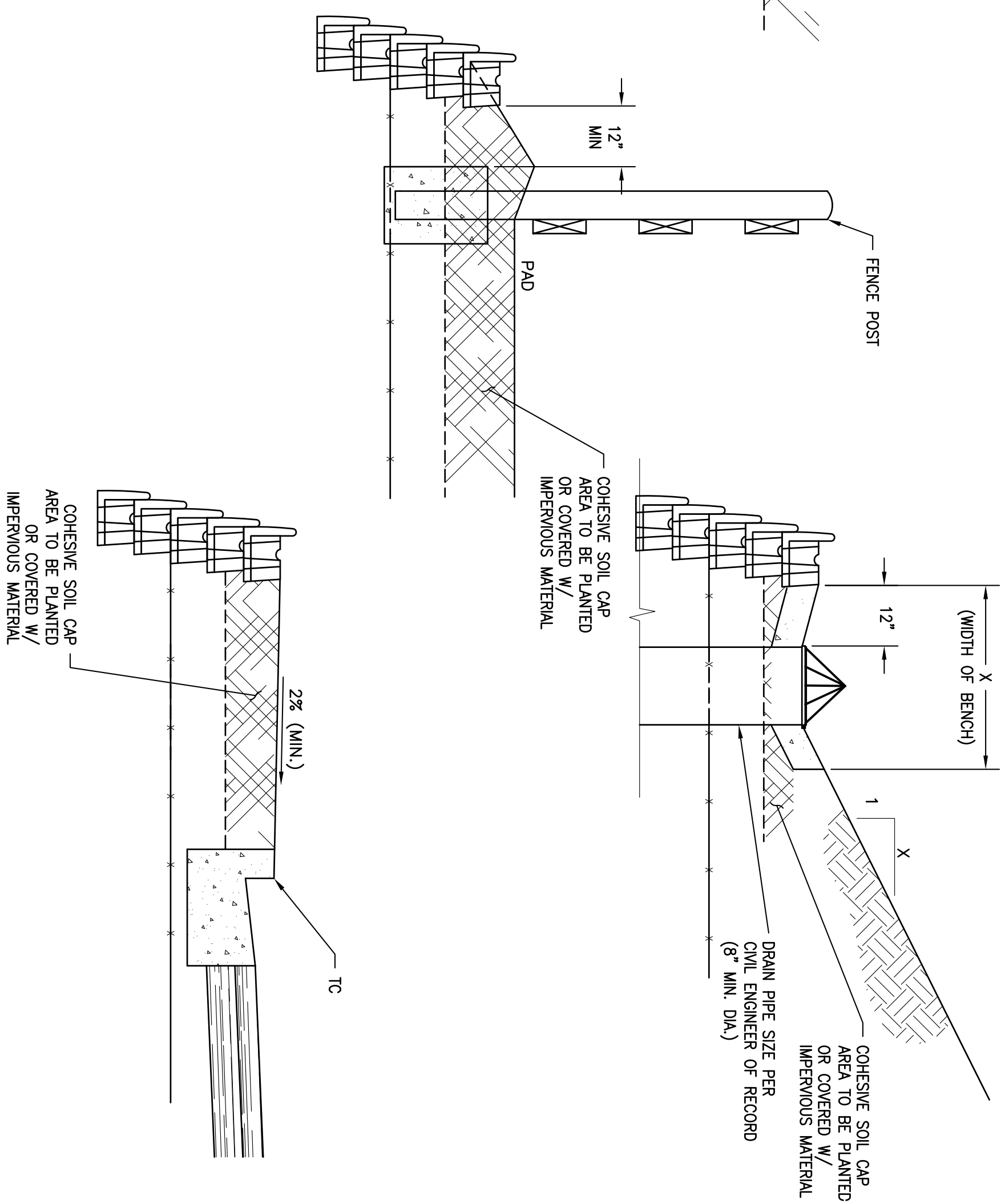
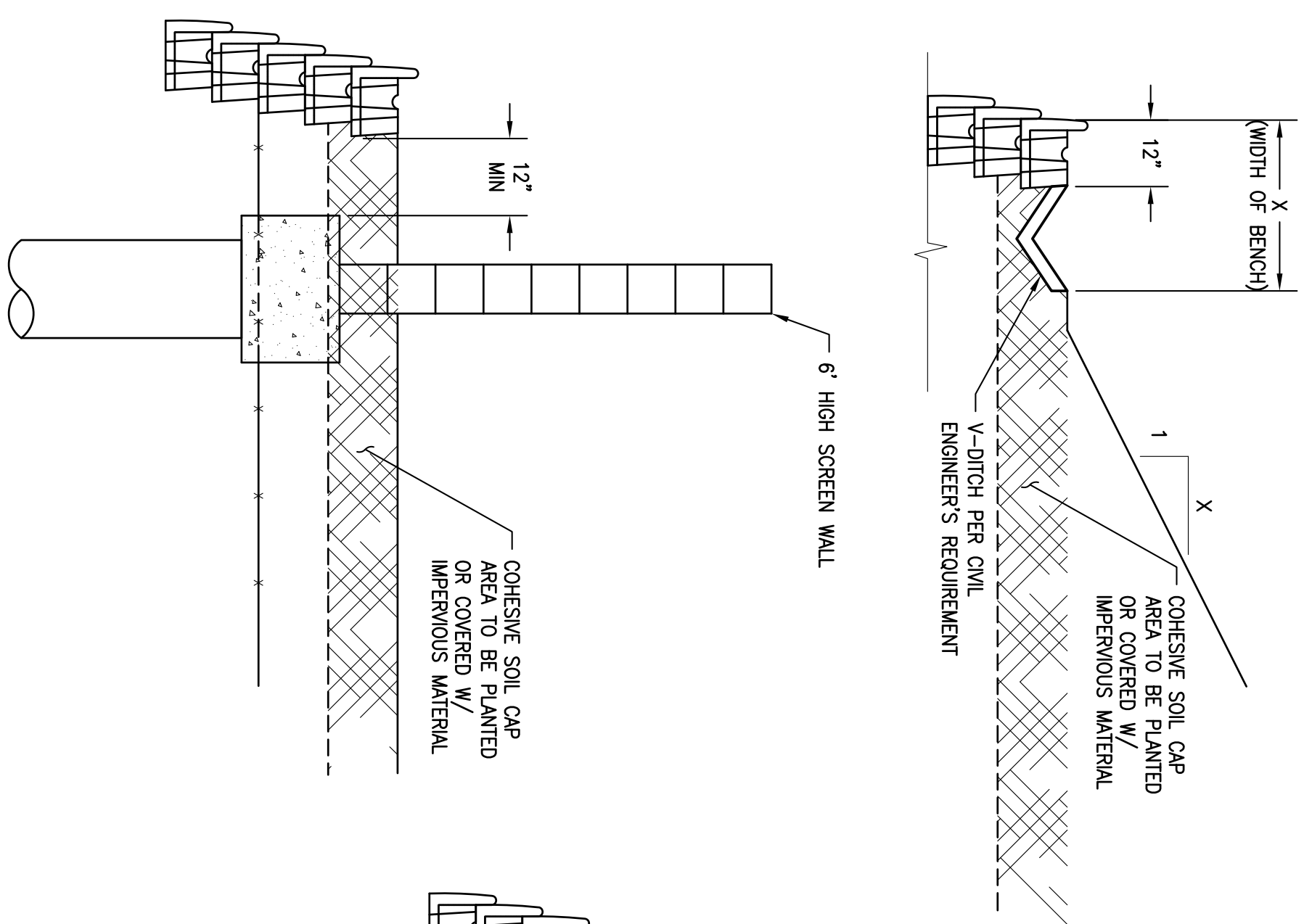

TOP OF WALL DETAILS  
SCALE: 1/2"=1'

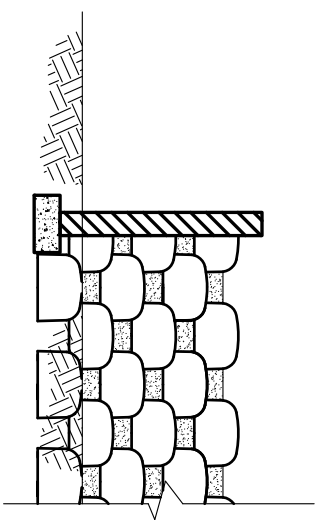
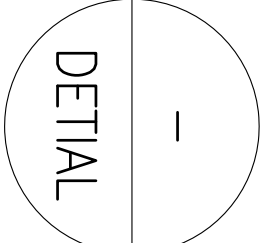

CASE A

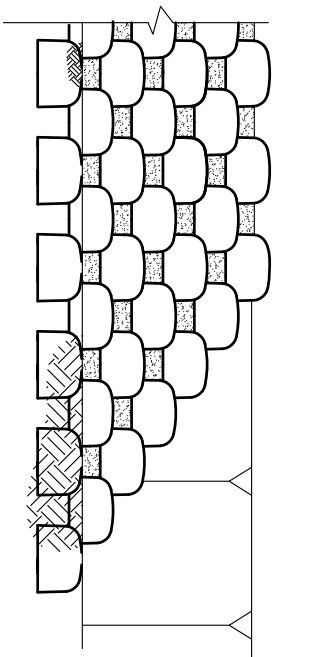

CASE B

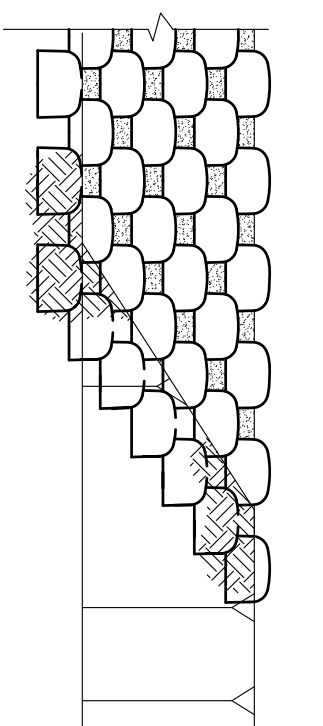

CASE C

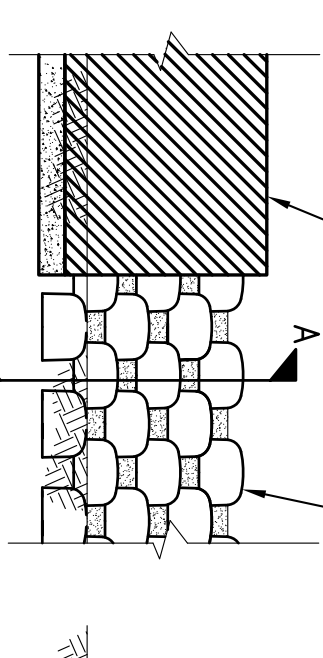

CASE D

END OF WALL TRANSITION DETAILS  
SCALE: 1/4"=1'

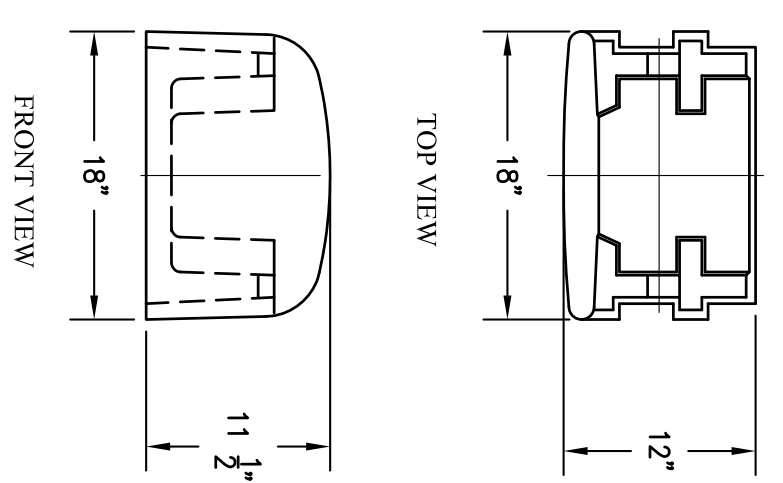

VERDURA 40 BLOCK DETAIL  
SCALE: 1"=1'

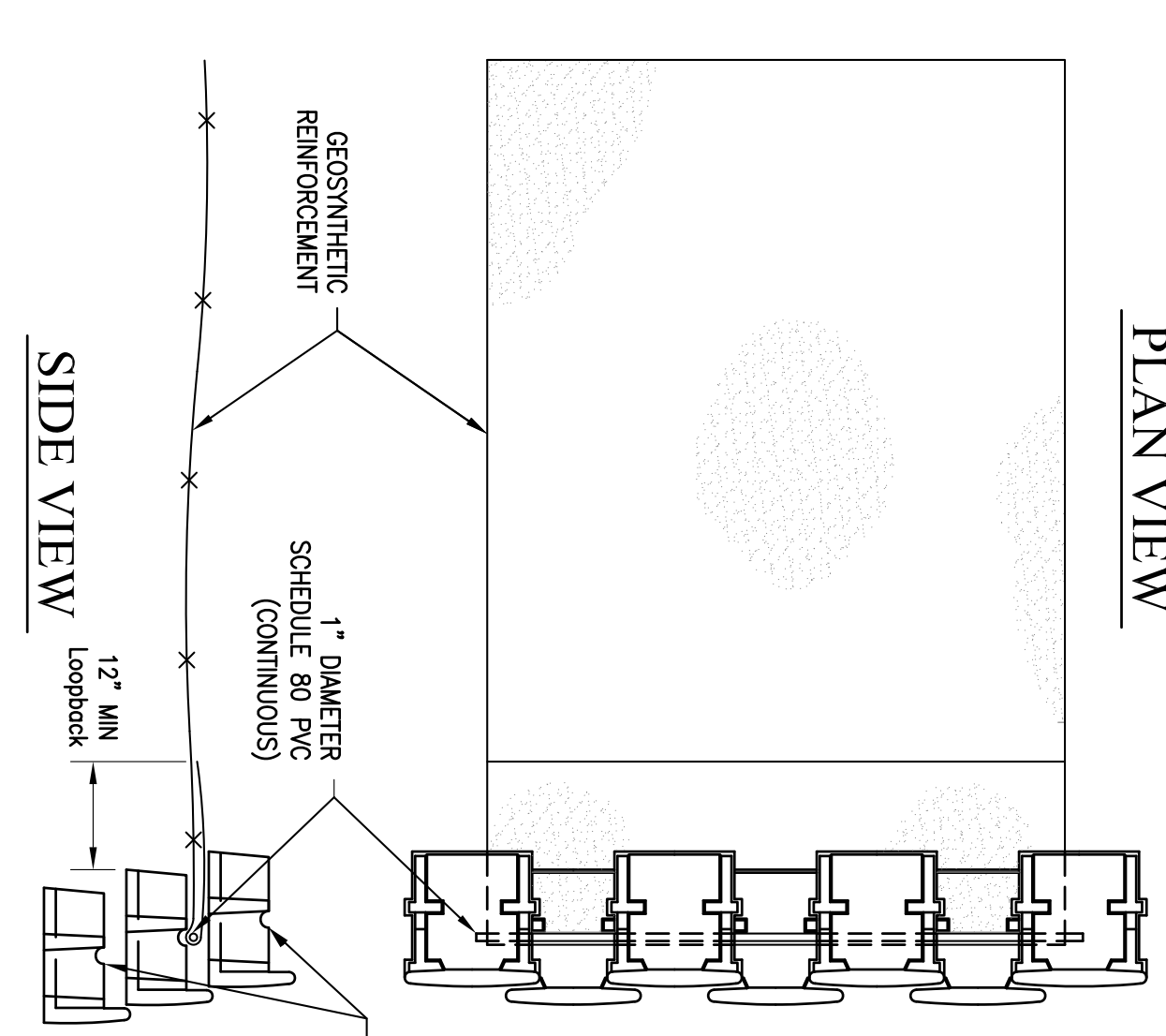

GEOSYNTHETIC CONNECTION DETAIL  
SCALE: 1/2"=1'

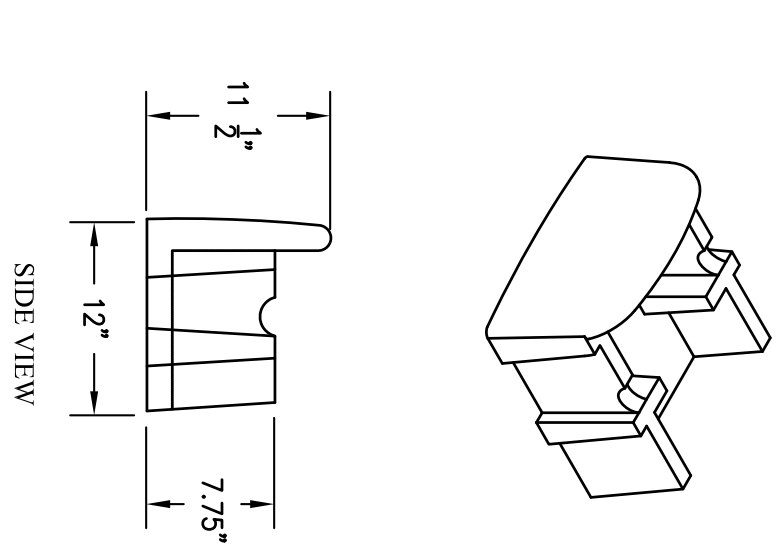

BLOCK SPACING DETAIL  
SCALE: 1"=1'

PREPARED BY:		SOIL RETENTION PRODUCTS	
VERDURA-40		MSE STRUCTURE TYPICAL DETAILS	
DRAWN BY:	MSB	DESIGNED BY:	MSB
CHECKED BY:	NEU	DATE:	
SHT. NO.		SCALE:	AS SHOWN

Soil Retention Products, Inc.  
2501 State Street, Carlsbad, CA 92008  
760-966-6090, 800-346-7995, Fax 760-966-6099  
www.soilretention.com